



CNC Video Measuring System

NEXIV

VMZ-R Series

Standard Model



NEXIV VMZ-R Series

Optical Heads

Type 1, 2 and 3 – Standard magnification zooming heads

Type 1 0.5x~7.5x **Type 2** 1x~15x **Type 3** 2x~30x

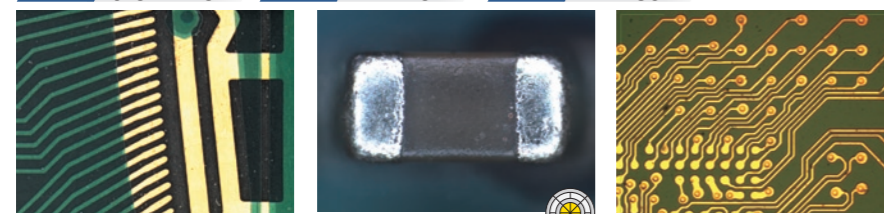

Printed circuit board
(optical magnification 1x)
Type 1 / 8 segment LED ring light

Printed circuit board
(optical magnification 2x)
Type 2 / 8 segment LED ring light

High density PCB
(optical magnification 1x)
Type 2 / coaxial top light

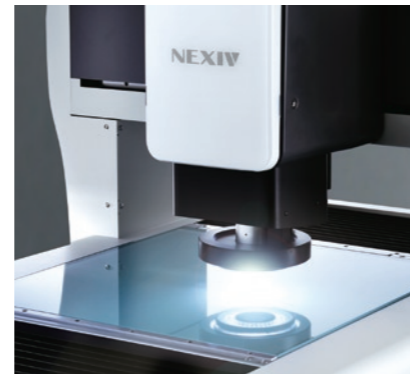

Type 4 and TZ – High magnification zooming heads

Type 4 4x~60x **Type TZ** 1x~7.5x/16x~120x



High density PCB
(optical magnification 16x)
Type 4 / coaxial top light

IC chip
(optical magnification 8x)
Type 4 / coaxial top light

High density PCB
(optical magnification 16x)
Type TZ / dark field illumination

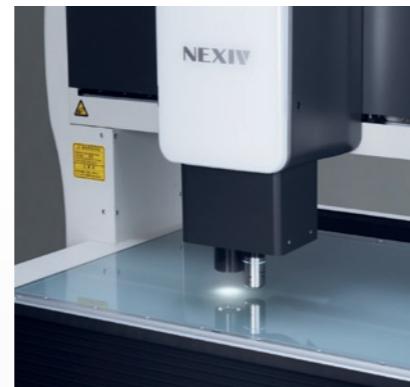

Type A - Wide FOV zooming head **Type A** 0.35x~3.5x

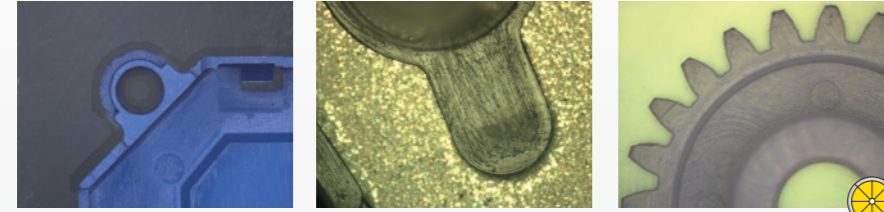

Plastic molded part
(optical magnification 0.35x)
Coaxial top light

Plastic molded part
(optical magnification 0.6x)
Coaxial top light

Resin parts
(optical magnification 0.35x)
8 segment LED ring light

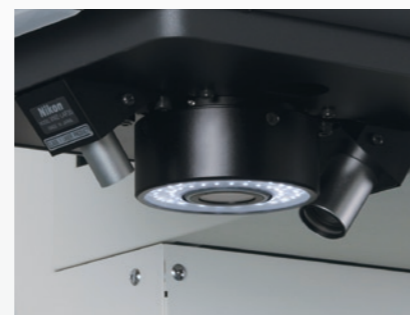

Stage Sizes

300mm(X) × 200mm(Y) × 200mm(Z) – Standard stroke

VMZ-R 3020

Suitable for small components used for products such as mechanical, electric/electronic, automotive, and medical devices.

- Type 1~3** Connectors, semiconductor packages, small PCB's, small stamped sheet metal parts, lead frames, watch components, etc.
- Type 4 / TZ** High density PCB's, lead frames, semiconductor packages, MEMS, probe cards, etc.
- Type A** Plastic molded parts, sheet metal parts, rubber parts, mechanical parts, implant components, watch components, etc.



450mm(X) × 400mm(Y) × 200mm(Z) – Middle stroke

VMZ-R 4540

Designed for middle size components and/or series measurements of multiple pieces on the stage.

- Type 1~3** Middle size PCB's, stamped sheet metal parts, etc.
- Type 4 / TZ** 300mm wafers, 300mm probe cards, etc.
- Type A** Middle size mechanical parts, plastic molded parts, etc.

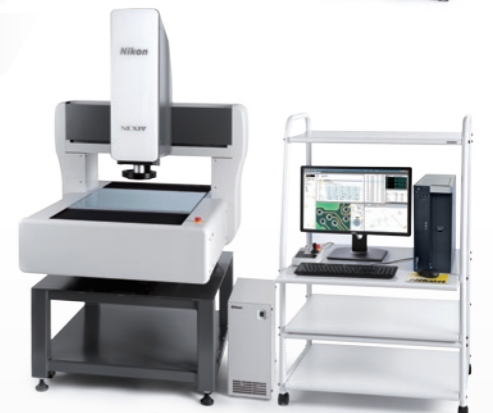

650mm(X) × 550mm(Y) × 200mm(Z) – Large stroke

VMZ-R 6555

Suitable for large size components and/or "step-and-repeat" measurements of multiple pieces on the stage.

- Type 1~3** Large PCB's, large plastic molded parts, etc.
- Type 4 / TZ** High density large PCB's, etc.
- Type A** Large stamped sheet metal parts, Large plastic molded parts, etc.



Optical magnification		0.35	0.5	0.6	1	1.8	2	3.5	4	7.5	8	15	16	30	32	60	64	120
Standard magnification zooming heads	Type 1		●	●	●	●	●	●	●	●								
	Type 2				●	●	●	●	●	●	●	●	●	●				
	Type 3											●	●	●	●			
High magnification zooming heads	Type 4								●	●	●	●	●	●	●	●	●	●
	Type TZ				●	●	●	●	●	●	●	●	●	●	●	●	●	●
Wide FOV zooming head	Type A	●	●	●	●	●	●	●										
FOV size on stage	Horizontal (mm) × Vertical (mm)	13.3	9.33	7.8	4.7	2.6	2.33	1.33	1.165	0.622	0.582	0.311	0.291	0.155	0.146	0.078	0.073	0.039
		10.0	7.01	5.8	3.5	1.9	1.75	1.00	0.875	0.467	0.437	0.233	0.218	0.117	0.109	0.058	0.055	0.029
Total magnification on PC monitor		12.6	18	21.6	36	64.8	72	126	144	270	288	540	576	1080	1152	2160	2304	4320

* Total magnification is that of video window with 640 × 480 pixels on 24 inch WUXGA monitor (1920 × 1200 pixels) recommended for VMZ-R series.

Type 1, 2 and 3 – Standard magnification zooming heads

Equipped with excellent Nikon optics

Zooming heads are equipped with 15x zoom optics made exclusively for the NEXIV VMZ-R series. These Nikon optics feature a long working distance, a high NA of 0.35, low distortion, and low magnification error.

Optical magnification		0.5	1	2	4	7.5	8	15	16	30	
Magnification Type	Type 1 (0.5 to 7.5x)	0.5x	1x	2x	4x	7.5x	8x	15x	16x	30x	
	Type 2 (1 to 15x)	1x	2x	4x	8x	15x					
	Type 3 (2 to 30x)	2x	4x	8x	16x	30x					
FOV size on stage	Horizontal × Vertical (mm)	9.33 × 7.01	4.7 × 3.5	2.33 × 1.75	1.165 × 0.875	0.622 × 0.467	0.582 × 0.437	0.311 × 0.233	0.291 × 0.218	0.155 × 0.117	
1/3" CCD size	Horizontal × Vertical (mm)	4.8 × 3.6									
Video magnification		36									
Total magnification on Video Window (640 × 480 pixels)		18	36	72	144	270	288	540	576	1080	
Size of 1 pixel (micrometer)		14.7	7.36	3.68	1.84	0.98	0.82	0.48	0.46	0.24	
Size of objects on Video Window (640 × 480 pixels)	0.01x (mm)	0.18	0.36	0.72	1.44	2.7	2.88	5.4	5.76	10.8	
	0.1x (mm)	1.8	3.6	7.2	14.4	27	28.8	54	57.6	108	
	1x (mm)	18	36	72	144	270	288	540	576	1080	
Optical magnification		0.5	1	2	4	7.5	8	15	16	30	

* Total magnification is that of video window with 640 × 480 pixels on 24 inch WUXGA monitor (1920 × 1200 pixels) recommended for VMZ-R series.

TTL Laser AF with 50mm working distance (TTL - Through the lens)

Type 1, 2 and 3 zooming heads are equipped with TTL Laser AF with a long working distance 50mm. TTL Laser AF can work and show a high repeatability, independent from magnification used. It can also be used for scanning the surface by detecting a maximum of 1000 points per second. TTL Laser AF can detect both top and bottom surfaces of a transparent layer for measuring thickness of the transparent layer or the depth to surface of the layer under the transparent layer.

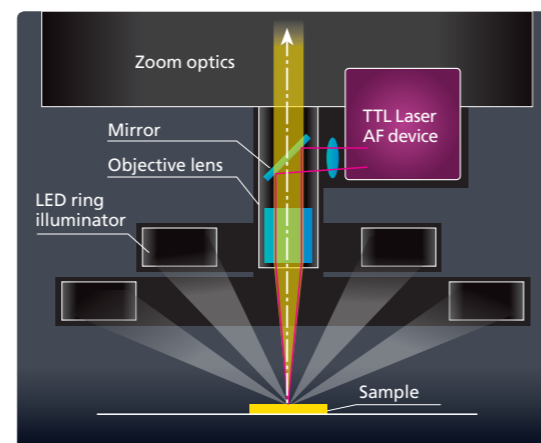

TTL Laser AF schematic

Focusing mode	Zooming head moves to focus point, passes it and returns to it.
Trigger mode	Zooming head moves to focus point and passes it and does not return to it (for reduction of measuring time).
Tracking mode	Zooming head moves to focus point and stops there and does not pass it (for further reduction of measuring time).
Searching mode	Zooming head detects 2 surfaces reflecting laser beam and you can choose a surface to detect.

Measurement support provided by Vision AF

Used for samples difficult to detect with TTL Laser AF, Vision AF is suitable to measure the height of rough surfaces and depth of small/deep holes.

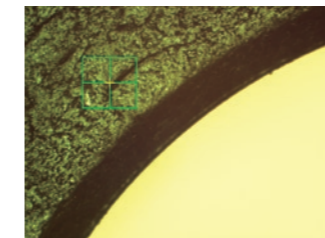

• **Surface mode**
Focus on surface of objects

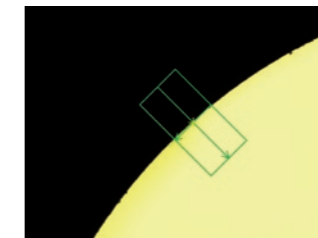

• **Contrast mode**
Focus on edges contoured by the bottom light

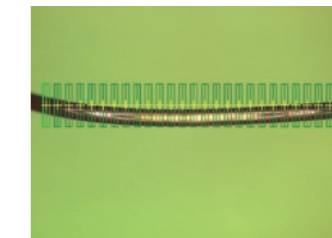

• **Multi mode**
Measure height of multiple points in the FOV

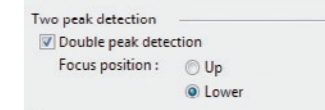

• **2 peak detection**
Obtain higher or lower focus points

Versatile illumination designed for highlighting obscure edges

LED light sources have now replaced all the halogen light sources used on previous models. LEDs have a stable high color temperature, which does not change with intensity. This gives more natural images and shorter measurement times.

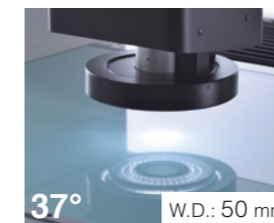

• **LED inner ring light**



• **LED outer ring light at 55 degree position**

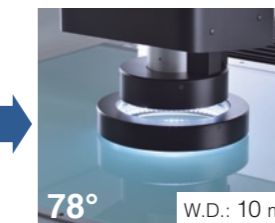

• **LED outer ring light at 78 degree position**

- 1 Diascopic and episcopic light control
- 2 Automatic adjustment of diascopic and episcopic light intensity
- 3 Ring light control – angle and direction
- 4 Rotation of ring light direction
- 5 Ring light intensity control

The inner 8 segment LED ring illuminator has 37 degree oblique angle to optical axis and the outer 8 segment LED ring illuminator has 55 and 78 degrees, that can easily define edges which are almost invisible to coaxial top light.

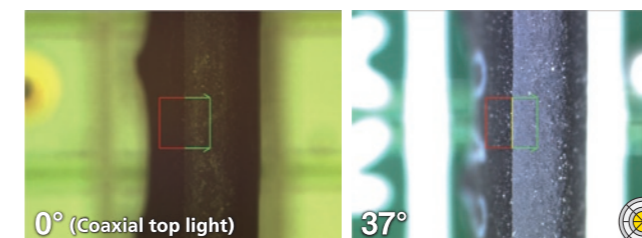

• **Coaxial top light / 37 degree oblique light**
(Connector at optical magnification 5x)

Obscure edges under coaxial top light are visible with LED ring lights.

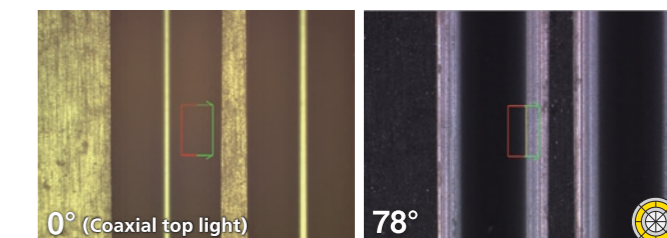

• **Coaxial top light / 78 degree oblique light**
(Drill at optical magnification 5x)

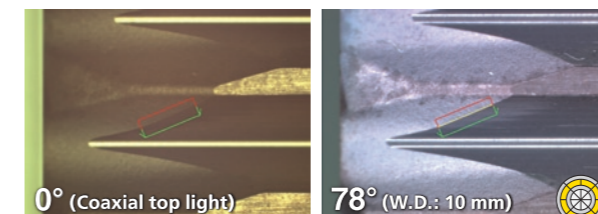

• **Coaxial top light / 78 degree oblique light / 55 degree oblique light**
(Drill at optical magnification 5x)

An obscure edge under coaxial top light is visible with oblique lights. 55 degree oblique light with a 36 mm working distance has an effect similar to the 78 degree oblique light with a working distance of 10 mm.

Type 4 – High magnification zooming head

Ideal for measuring high density samples with tiny features Type 4

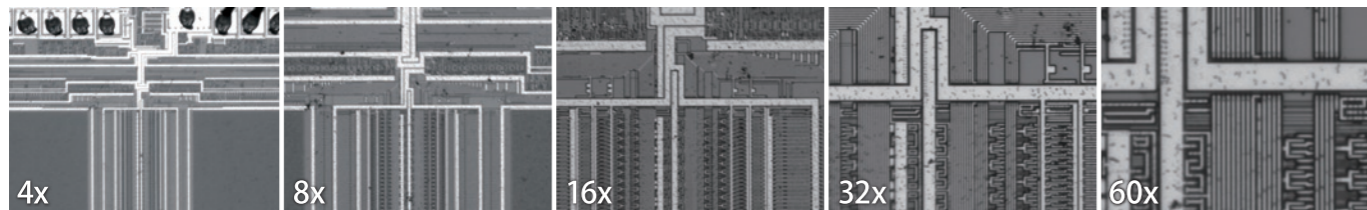

Type 4 has a 4 to 60x optical magnification, twice that of Type 3. The objective lens is designed with a high NA of 0.46 and a long working distance of 30mm.

Optical magnification		4	8	16	32	60
FOV size on stage	Horizontal × Vertical (mm)	1.165	0.582	0.291	0.146	0.078
		0.875	0.437	0.218	0.109	0.058
1/3" CCD size	Horizontal × Vertical (mm)	4.8×3.6				
Video magnification		36				
Total magnification on Video Window (640 × 480 pixels)		144	288	576	1152	2160
Size of 1 pixel (micrometer)		1.84	0.82	0.46	0.23	0.12
Size of objects on Video Window (640 × 480 pixels)	0.01× (mm)	1.44	2.88	5.76	11.52	21.6
	0.1× (mm)	14.4	28.8	57.6	115.2	216
	1× (mm)	144	288	576	1152	2160

* Total magnification is that of video window with 640 × 480 pixels on 24 inch WUXGA monitor (1920 × 1200 pixels) recommended for VMZ-R series.

8-segment LED ring illuminator suited for various samples Type 4

Type 4 is equipped with an 8-segment LED ring illuminator, as well as episcopic and diasopic illuminators, that make obscure edges stand out.

Subtle edges can be detected by utilizing the 50 degree oblique angle of the 8-segment ring illuminator.

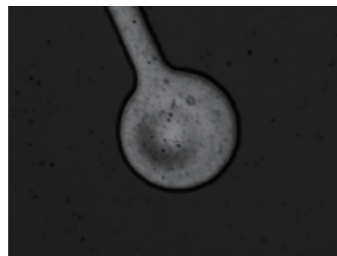
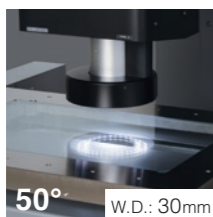

High density PCB
Coaxial illumination
at optical magnification 4x

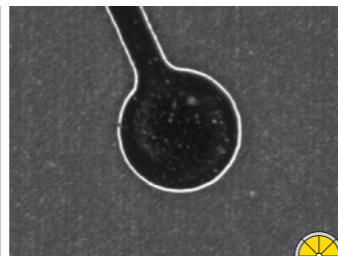

8-segment LED ring light



Lead frame
Episcopic illumination
at optical magnification 4x

2 types of AF available as standard Type 4

TTL Laser AF

TTL Laser AF, with a working distance of 30mm, can detect both the top and bottom layers of thin samples, such as transparent samples of 0.1mm thickness. By scanning 1000 points per second, the TTL Laser AF not only offers high accuracy, but also speed.

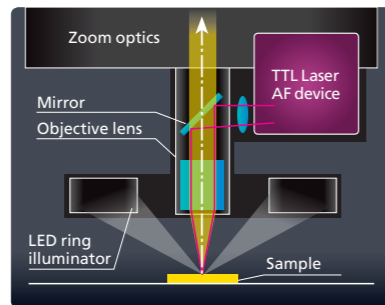

TTL Laser AF schematic

Vision AF

Vision AF can detect surfaces that cannot be reached with the Laser AF. The bottom surface of deep holes and the height of steep surfaces can be detected and measured with Vision AF.

Type TZ – High magnification zooming head

Type TZ zooming head range 1x to 120x Type TZ

Type TZ high magnification zooming head is equipped with two objective lenses that can be easily switched, offering a total of 1 to 120x optical magnifications. From low magnification to high magnification to measure tiny features, such as 1 micrometer line width, Type Z covers a wide range of measurement area.

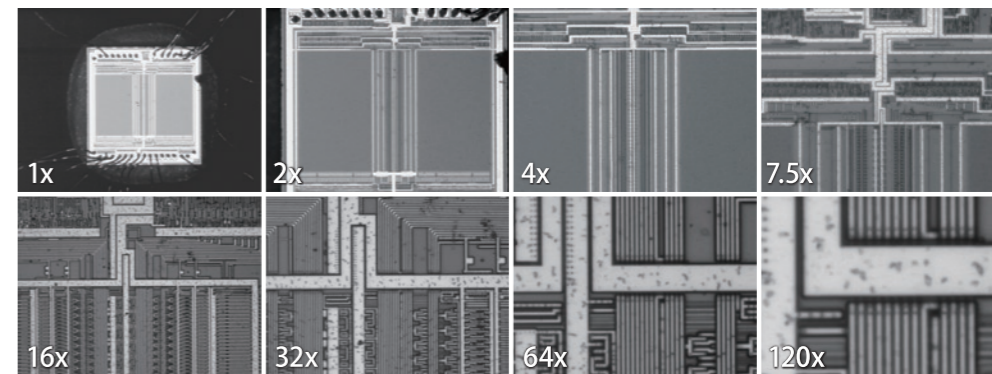

Optical magnification		1	2	4	7.5	16	32	64	120
FOV size on stage	Horizontal × Vertical (mm)	4.7	2.33	1.165	0.622	0.291	0.146	0.073	0.039
		3.5	1.75	0.875	0.467	0.218	0.109	0.055	0.029
1/3" CCD size	Horizontal × Vertical (mm)	4.8×3.6							
Video magnification		36							
Total magnification on Video Window (640 × 480 pixels)		36	72	144	270	576	1152	2304	4320
Size of 1 pixel (micrometer)		7.36	3.68	1.84	0.98	0.46	0.23	0.11	0.06
Size of objects on Video Window (640 × 480 pixels)	0.01× (mm)	0.36	0.72	1.44	2.7	5.76	11.52	23.04	43.2
	0.1× (mm)	3.6	7.2	14.4	27	57.6	115.2	230.4	432
	1× (mm)	36	72	144	270	576	1152	2304	4320

* Total magnification is that of video window with 640 × 480 pixels on 24 inch WUXGA monitor (1920 × 1200 pixels) recommended for VMZ-R series.

TTL Laser AF highest among the VMZ-R series Type TZ

Type TZ main objective lens has TTL Laser AF built-in. High NA (0.55) lens has the highest performance in terms of detecting and scanning.

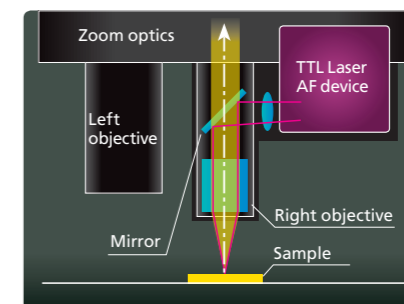

TTL Laser AF schematic

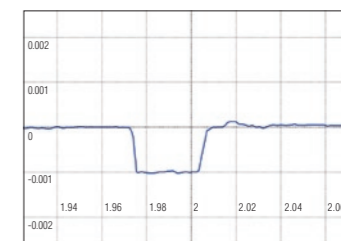

Cross section of a small groove

CNC controlled illuminations Type TZ

Offers coaxial, episcopic, and darkfield illuminations to detect edges of tiny features.

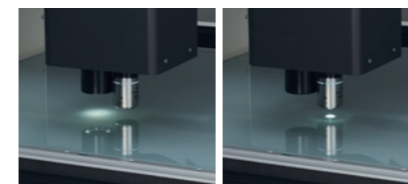

Objective lenses for Type TZ

Left: 1 to 7.5x
Right: 16 to 120x

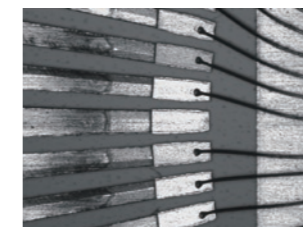

Lead frame
Coaxial illumination
at optical magnification 1x



Episcopic illumination

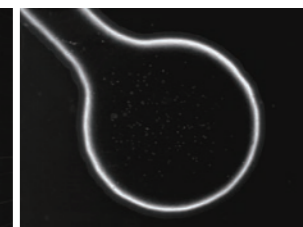

High density PCB
Darkfield illumination
at optical magnification 16x

Type A – Wide FOV zooming head

Features a wide FOV and long working distance

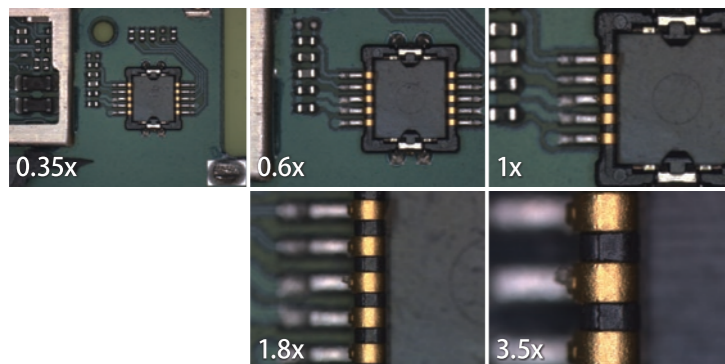

With a maximum of 13.3 × 10 mm FOV at 0.35x, the wide FOV is available for samples with large features.

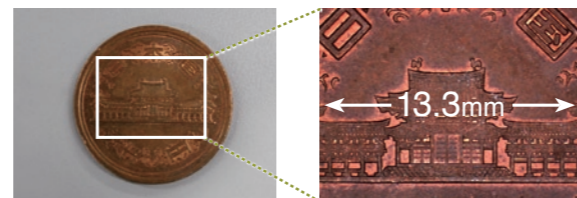

10 yen coin
Under coaxial top light
at 0.35x optical magnification

Optical magnification		0.35	0.6	1	1.8	3.5
FOV size on stage	Horizontal × Vertical (mm)	13.3 10.0	7.8 5.8	4.7 3.5	2.6 1.9	1.33 1.00
1/3" CCD size	Horizontal × Vertical (mm)	4.8×3.6				
Video magnification		36				
Total magnification on Video Window (640 × 480 pixels)		12.6	21.6	36	64.8	126
Size of 1 pixel (micrometer)		21.8	12.6	7.36	4.25	2.15
Size of objects on Video Window (640 × 480 pixels)	0.01× (mm)	0.126	0.216	0.36	0.648	1.26
	0.1× (mm)	1.26	2.16	3.6	6.48	12.6
	1× (mm)	12.6	21.6	36	64.8	126

At all magnifications, a working distance of 73.5 mm can be realized. Type A is suitable for measuring low density samples with wide steps and/or deep holes.

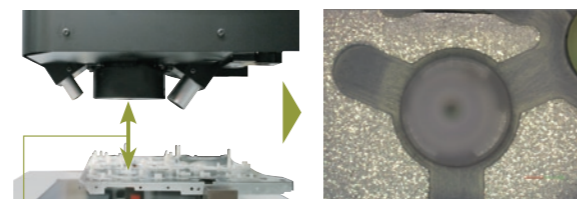

Working distance
73.5 mm

Assembled components
Under coaxial top light
at 0.35x optical magnification

Vision AF and Laser AF

The search probe can detect misaligned parts, and rotate the program to suit, allowing for successful measurement with the Vision AF. With a 63 mm working distance, the Laser AF option for Type A offers high accuracy, independent of magnification and its depth of focus.

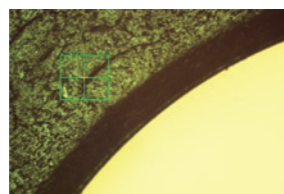

Focusing on a surface
(Vision AF Surface mode)

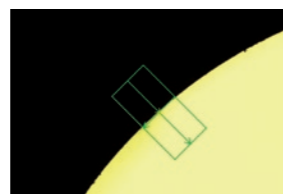

Focusing on an edge
(Vision AF Contrast mode)

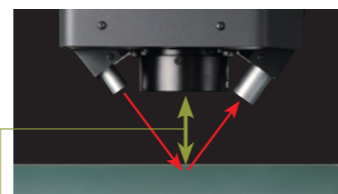

Working distance
63 mm (Laser AF)

Illumination lineup for various needs

Equipped with episcopic, diasopic and 8-segment ring illuminators. Obscure edges can be visualized by using the 8-segment ring illuminator with an oblique angle of 18 degrees.



Plastic molded part
Under coaxial top light
at 0.35x optical magnification

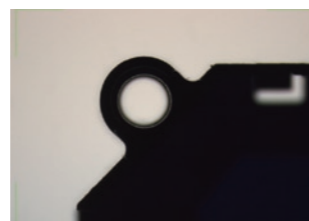

Episcopic illumination



8-segment LED ring light

Software

Edge and point selection

Preset rules for selecting the correct edge with multiple edge candidates and a filter to avoid abnormal points to minimize errors.

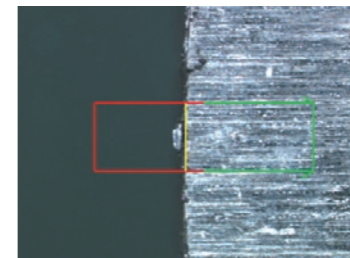

Intelligent search function

Measures by searching preset shapes/patterns. Misaligned samples can be found and measured without failure.

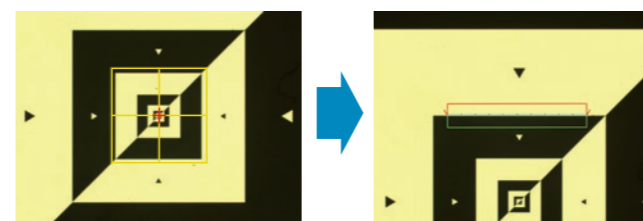

Automatically finds the shape that was preset

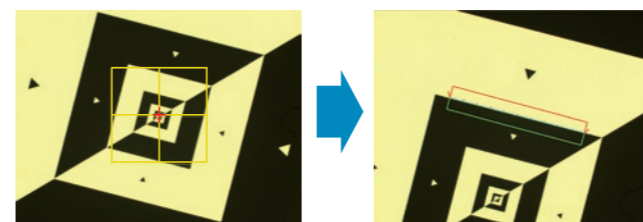

"Rotate search" detects the misaligned samples and automatically rotates the program to suit for measurement.

Evaluation of shapes

Errors can be visualized by overlaying nominal and measured shapes. Can be used for both geometrical shapes and free-form shapes.

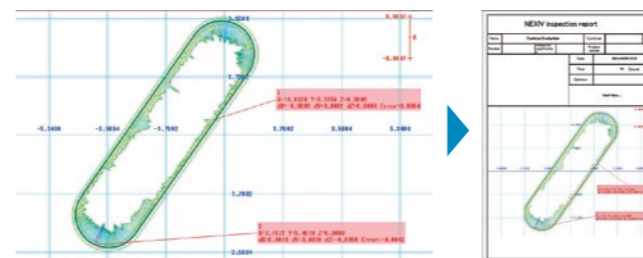

- Calculation of errors can be made in normal or axis direction
- Nominal shapes can be made from CAD data or XYZ coordinate values
- Measured shapes can be output as CSV or DXF files
- Evaluation reports can be made in PDF files

Digital Operation Guide NEXIV Note Ver.1.0

Offers slides and movies with NEXIV contents, such as basic operations and functions. Simple measurement programs can be created by referring to this application.

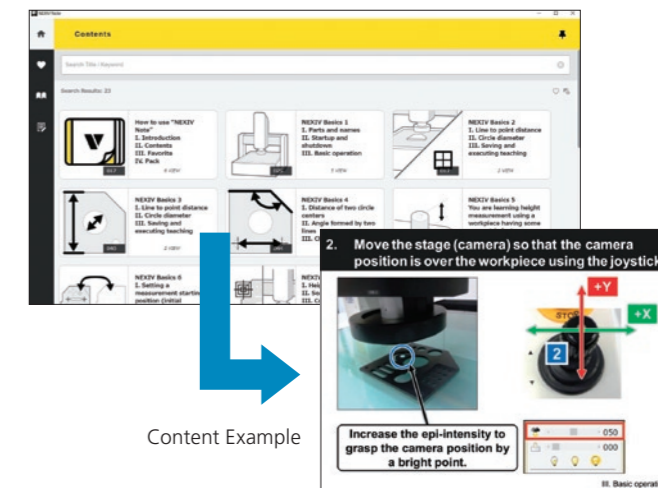

Content Example

- Search: search by related words
- Favorite: list only selected contents
- Memo: share information by creating memos
- Pack List: sort by related contents
- Stay on top: display in the foreground on screen

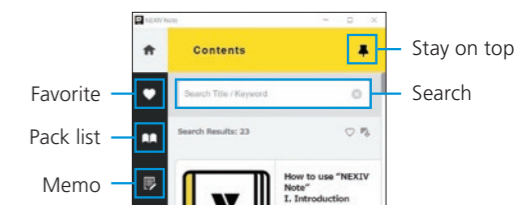

Other functions

Import of CAD data CAD data can be imported and shown in the graphic window.

Export of DXF data Features measured can be exported as DXF data.

Off-line teaching Teaching files can be made on CAD data.

Reporting measured data Easily made by choosing graphics and layouts.

Calculations based on ISO and JIS standards Circle (roundness), plane (flatness), line (straightness) are available.

Optional Software

EDF/Stitching Express

Images taken with the VMZ-R can be stitched to get a larger image, while images at different heights can result with an image with Extended Depth of Focus (EDF). Stitching and EDF can produce 3D graphics.



Original image 3D graphic from EDF

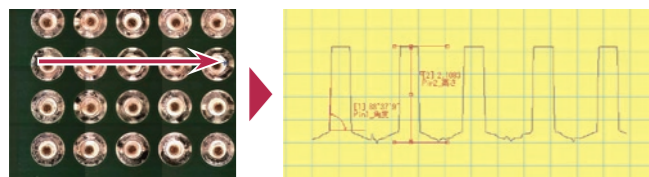

Original image Cross section from EDF and stitching

MountainsMap X

Sample surfaces can be analyzed, based on ISO, with the data exported from VMZ-R.

Manufactured by Digital Surf (France)

Pseudo-color view of the surface 3D view of the surface

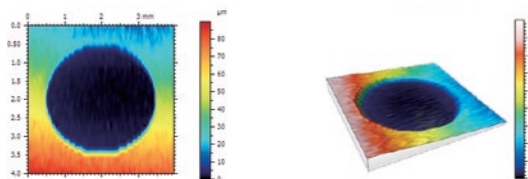

Profile curve

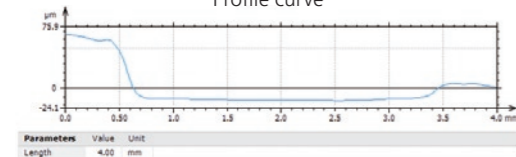

Pseudo-color view of the surface

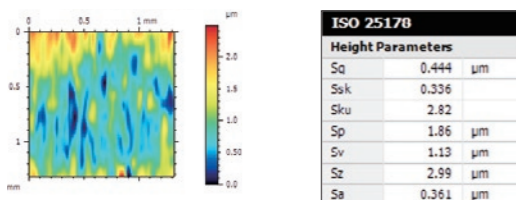

Roughness curve

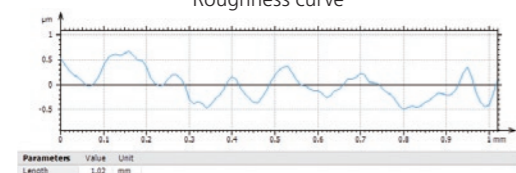

ImageFit QC

Creates inspection reports according to any designated format. Measurement results can be automatically reflected with pass/fail results and statistical results*. Line graphs and histograms can also be created as needed.

*standard deviation, process capability index (Cp, Cpk)

*Excel is required

Codeveloped by Aria Co., Ltd. (Japan)



Parameter Settings

Report of Measurement Results

Custom Fit QC

Measurement results are read into 10 different templates and pass/fail results and calculation results*1 are automatically exported. Graphs*2, including X-R control charts and scatter diagrams, can be automatically generated to visualize measurement results.

*1: Average, maximum value, minimum value, range, standard deviation, and process capability index (Cp, Cpk)

*2: Line graphs, histograms, X-R control charts, scatter diagrams

*Excel is required

Codeveloped by Aria Co., Ltd. (Japan)

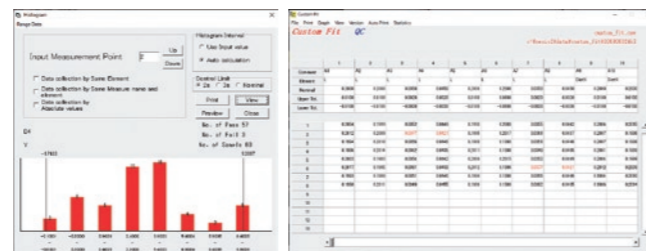

MapMeasure Pro

MapMeasure Pro creates wafer maps and is capable of automatically measuring any die on the wafer map. Tray maps can also be created.

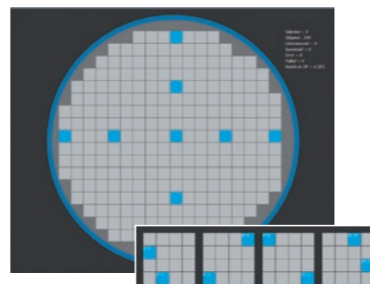

Dimensions

Controller: 190×450×440 mm / 15 kg

VMZ-R 3020

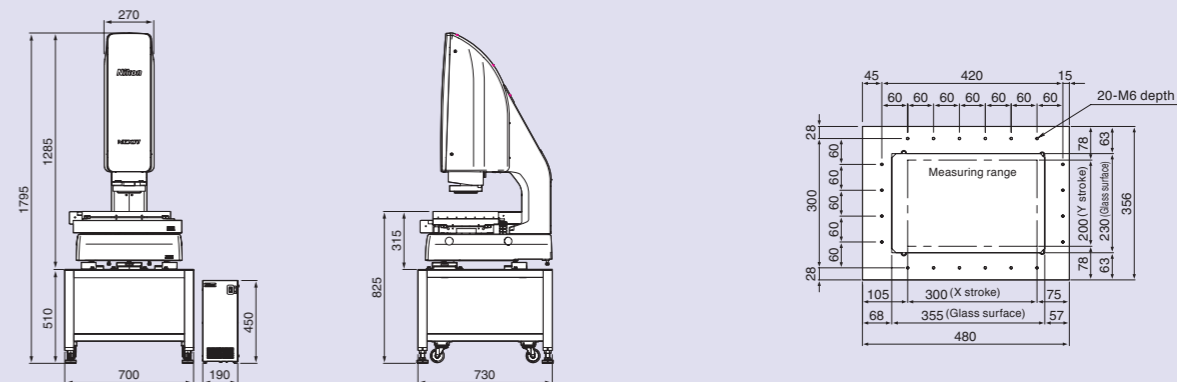

Main body with table: 700×730×1795 mm / approx. 245 kg Footprint including a PC on table: 2100×1100 mm

VMZ-R 4540

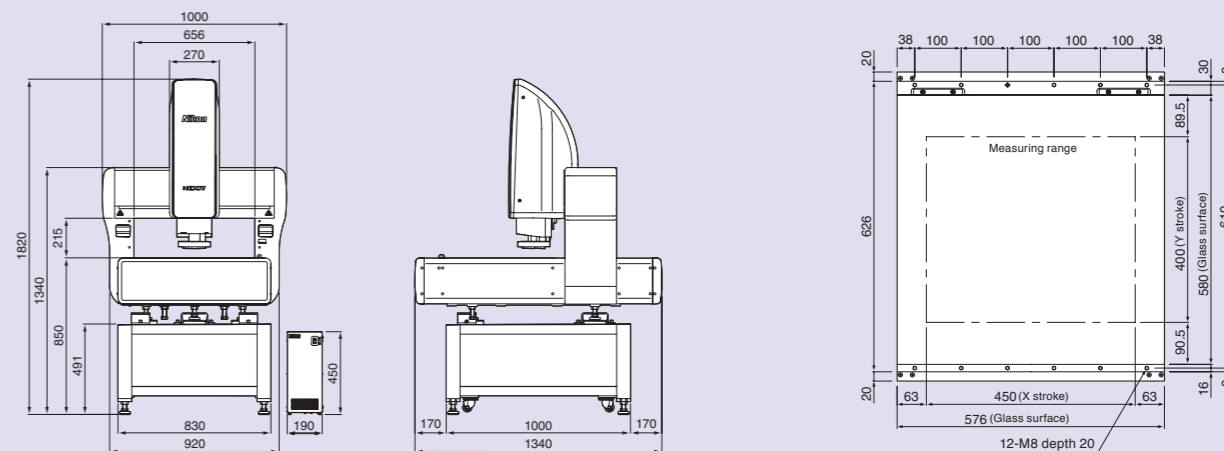

Main body with table: 1000×1340×1820 mm / approx. 500 kg Footprint including a PC on table: 2300×1700 mm

VMZ-R 6555

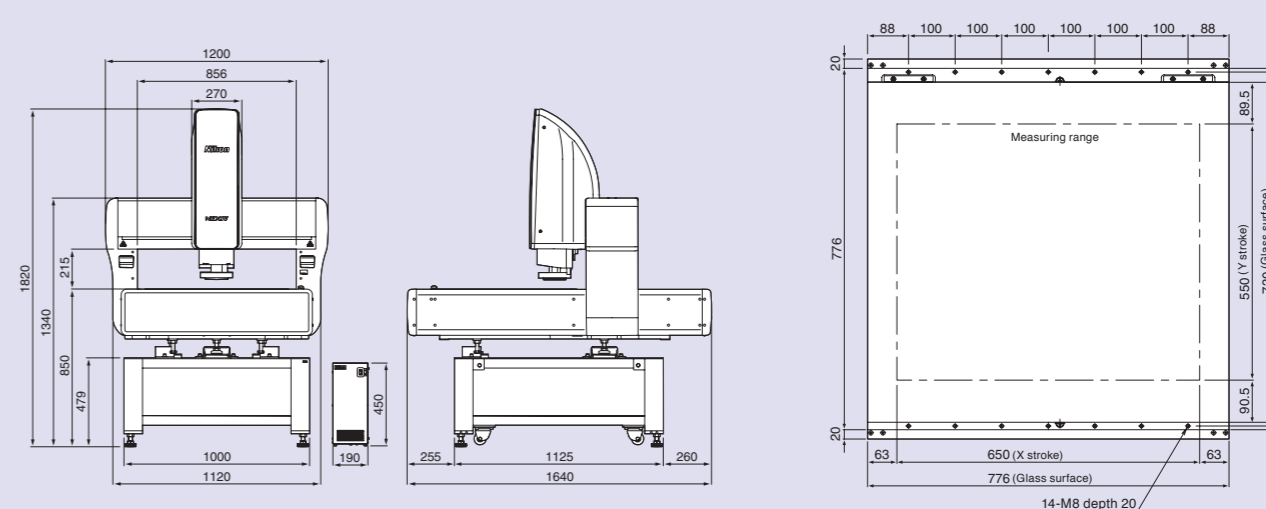

Main body with table: 1200×1640×1820 mm / approx. 665 kg Footprint including a PC on table: 2400×2000 mm

Specifications

Model	VMZ-R 3020	VMZ-R 4540	VMZ-R 6555
XYZ strokes			
Type 1, 2, 3 and 4	300×200×200 mm	450×400×200 mm	650×550×200 mm
Type TZ with high magnification lens	300×200×200 mm	450×400×200 mm	650×550×200 mm
Type TZ with low magnification lens	250×200×200 mm	400×400×200 mm	600×550×200 mm
Type A	300×200×200 mm	450×400×200 mm	650×550×200 mm
Minimum readout	0.01 micrometer		
Maximum sample weight	20 kg	40 kg	50 kg
Maximum permissible error (L: Length in mm)	EUX, MPE: $EUY, MPE: 1.2+4L/1000 \mu m$ EUXY, MPE: $2+4L/1000 \mu m$ EUY, MPE: $1.2+5L/1000 \mu m$		
Camera	1/3" Black and White CCD, 1/3" Color CCD *Color camera option is available only with Type 1, 2 and A		
Working distance of objective lens			
Type 1, 2 and 3	50 mm with 37 degree oblique angle, 36 mm with 55 degree oblique angle, 10 mm with 78 degree oblique angle		
Type 4	30 mm		
Type TZ	11 mm with right objective lens, 32 mm with left objective lens		
Type A	73.5 mm (63 mm with Laser AF)		
Magnification and FOV	Type 1: $0.5\sim 7.5\times / 9.33 \times 7 \sim 0.622 \times 0.467 \text{ mm}$ Type 3: $2\sim 30\times / 2.33 \times 1.75 \sim 0.155 \times 0.117 \text{ mm}$ Type TZ: $1\sim 120\times / 4.67 \times 3.5 \sim 0.039 \times 0.029 \text{ mm}$	Type 2: $1\sim 15\times / 4.67 \times 3.5 \sim 0.311 \times 0.233 \text{ mm}$ Type 4: $4\sim 60\times / 1.165 \times 0.875 \sim 0.078 \times 0.058 \text{ mm}$ Type A: $0.35\sim 3.5\times / 13.3 \times 10 \sim 1.33 \times 1 \text{ mm}$	
Autofocus	Vision AF, Laser AF (option)		
Illumination			
Type 1, 2, 3, and 4	Episcopic, diascopic, and 8-segment ring with 3 angles *All white LED/Type 4 has only 1 angle		
Type TZ	Left objective lens: Episcopic, darkfield ; Right objective lens: Episcopic, diascopic, darkfield		
Type A	Episcopic, diascopic, and 8-segment ring with 1 angle *All white LED		
Power source	AC 100-240V±10% 50/60 Hz		
Power consumption	5 A - 2.5 A		

Nikon Corporation Industrial Metrology Business Unit is certified as an ISO/IEC 17025 accredited calibration laboratory for CNC video measuring systems by the IAJapan (International Accreditation Japan) as Accreditation No. JCSS0241.

ISO/IEC 17025: International standard, which specifies the general requirements to ensure that a laboratory is competent to carry out specific tests and/or calibrations

Date of initial accreditation:	July 1, 2009
Scope of accreditation:	Coordinate measuring instruments
Accredited section:	Industrial Metrology Business Unit
Calibration site:	Customer's laboratory (field service)
Calibration and Measurement Capability (CMC), (K=2, Level of Confidence Approximately 95%) [L=measurement length (mm)]	$L \leq 420\text{mm}: 0.32 \mu m$ $420 \leq L \leq 1000\text{mm}: (0.29 + 0.64 \times L/1000) \mu m$

Specifications and equipment are subject to change without any notice or obligation on the part of the manufacturer. March 2020 ©2013-2020 NIKON CORPORATION
N.B. Export of the products* in this catalog is controlled under the Japanese Foreign Exchange and Foreign Trade Law. Appropriate export procedures shall be required in case of export from Japan.
*Products: Hardware and its technical information (including software)
Company names and product names appearing in this brochure are their registered trademarks or trademarks.



WARNING TO ENSURE CORRECT USAGE, READ THE CORRESPONDING MANUALS CAREFULLY BEFORE USING THE EQUIPMENT.



NIKON CORPORATION

Shinagawa Intercity Tower C, 2-15-3, Konan, Minato-ku, Tokyo 108-6290, Japan
phone: +81-3-6433-3701 fax: +81-3-6433-3784
<https://www.nikon.com/products/industrial-metrology/>

ISO 14001 Certified
for NIKON CORPORATION

ISO 9001 Certified
for NIKON CORPORATION
Industrial Metrology Business Unit

NIKON METROLOGY EUROPE NV

Geldenaaksebaan 329, 3001 Leuven, Belgium
phone: +32-16-74-01-00 fax: +32-16-74-01-03
E-mail: Sales.Europe.NM@nikon.com
<http://www.nikonmetrology.com/en-gb>

NIKON METROLOGY UK LTD.

UNITED KINGDOM phone: +44-1332-811-349 fax: +44-1332-639-881
E-mail: Sales.UK.NM@nikon.com

NIKON METROLOGY SARL

FRANCE phone: +33-1-60-86-09-76 fax: +33-1-60-86-57-35
E-mail: Sales.France.NM@nikon.com

NIKON METROLOGY GMBH

GERMANY phone: +49-6023-91733-0 fax: +49-6023-91733-229
E-mail: Sales.Germany.NM@nikon.com

NIKON INSTRUMENTS S.p.A.

ITALY phone: +39-055-300-96-01 fax: +39-055-30-09-93

NIKON METROLOGY, INC.

12701 Grand River Avenue, Brighton, MI 48116 U.S.A.
phone: +1-810-220-4360 fax: +1-810-220-4300
E-mail: Sales.NM-US@nikon.com
<http://www.nikonmetrology.com/en-us>

NIKON CANADA INC.

CANADA phone: +1-905-602-9676 fax: +1-905-602-9953

NIKON MEXICO- Metrology Showroom

MEXICO phone: +52 (442) 688 5067
E-mail: Sales.NM-MX@nikon.com

NIKON INSTRUMENTS (SHANGHAI) CO., LTD.

CHINA (Shanghai branch) phone: +86-21-6841-2050 fax: +86-21-6841-2060
(Beijing branch) phone: +86-10-5831-2028 fax: +86-10-5831-2026
(Guangzhou branch) phone: +86-20-3882-0551 fax: +86-20-3882-0580

NIKON INSTRUMENTS KOREA CO., LTD.

KOREA phone: +82-2-2186-8400 fax: +82-2-555-4415

NIKON SINGAPORE PTE LTD.

SINGAPORE phone: +65-6559-3651 fax: +65-6559-3668
E-mail: NSG.Industrial-sales@nikon.com

NIKON MALAYSIA SDN BHD

MALAYSIA phone: +60-3-7809-3688 fax: +60-3-7809-3633

PT. NIKON INDONESIA

INDONESIA phone: +62-267-864-3949 fax: +62-267-864-3950

E-mail: PTN.Instruments@nikon.com

NIKON SALES (THAILAND) CO., LTD.

THAILAND phone: +66-2633-5100 fax: 66-2633-5191

NIKON INDIA PRIVATE LIMITED

INDIA phone: +91-124-4688500 fax: +91-124-4688527